

SCT013G Split core current transformer



Product features

- Safety lock buckle, simple installation
- Audio connector output
- Lead type output, the length can be customized
- Suspended mounting

Installation diagram

One time threading

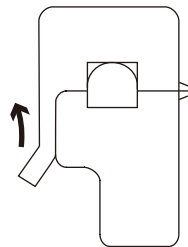

1. Open the buckle

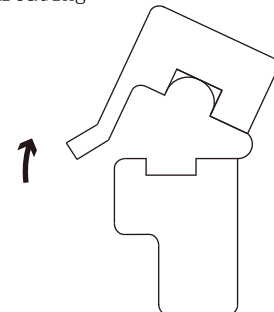

2. Open up

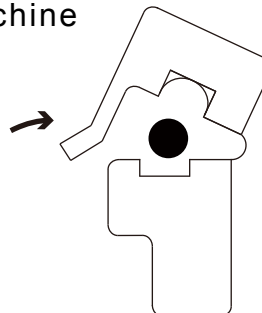

3. Drop lead

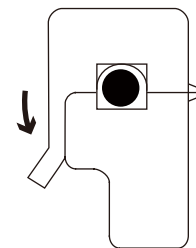

4. Fasten the buckle

Product application

- Portable instrument
- Household metering
- Monitoring the load of the machine

Product advantage

- Small volume, light weight
- Low cost
- High turns, high precision

Typical technical index:

- Material of core——Ferrite
- Working voltage——Phase voltage≤720V
- Working temperature——-25℃ ~ +60℃
- Storage temperature——-30℃ ~ +90℃
- Frequency range——50Hz~1KHz
- Electrical resistance——input (Bare conductor) /output AC 3.5KV/1min 5mA 50Hz
output/outer shell AC 3.5KV/1min 5mA 50Hz

Electrical parameters

Model	Input current	Output	Turns	Load resistance	Accuracy	Linearity	Weight
SCT013-000	100A	50mA	1: 2000	10 Ω	1%	1%	50g
SCT013-005	5A	1V	-	built-in	1%	1%	50g
SCT013-010	10A	1V	-	built-in	1%	1%	50g
SCT013-015	15A	1V	-	built-in	1%	1%	50g
SCT013-020	20A	1V	-	built-in	1%	1%	50g
SCT013-025	25A	1V	-	built-in	1%	1%	50g
SCT013-030	30A	1V	-	built-in	1%	1%	50g
SCT013-050	50A	1V	-	built-in	1%	1%	50g
SCT013-060	60A	1V	-	built-in	1%	1%	50g
SCT013-100V	100A	1V	-	built-in	1%	1%	50g

Model	Input current	Output	Turns	Load resistance	Accuracy	Linearity	Weight
SCT013	5A	0.333V	-	built-in	1%	1%	50g
SCT013	10A	0.333V	-	built-in	1%	1%	50g
SCT013	15A	0.333V	-	built-in	1%	1%	50g
SCT013	20A	0.333V	-	built-in	1%	1%	50g
SCT013	25A	0.333V	-	built-in	1%	1%	50g
SCT013	30A	0.333V	-	built-in	1%	1%	50g
SCT013	50A	0.333V	-	built-in	1%	1%	50g
SCT013	60A	0.333V	-	built-in	1%	1%	50g
SCT013	100A	0.333V	-	built-in	1%	1%	50g

Wiring schematic diagram:

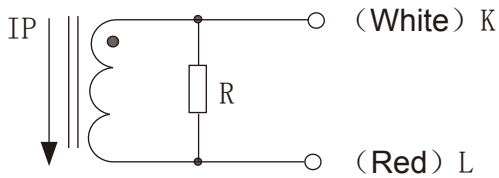

Built-in sampling resistance

Voltage output type

Secondary not allowed short circuit

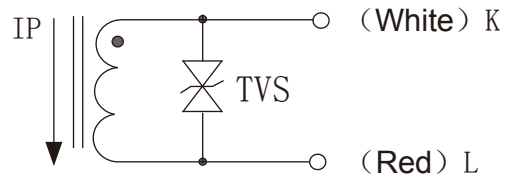

TVS: Transient voltage suppressor

Current output type

Secondary not allowed open circuit

Dimensions (in mm) :

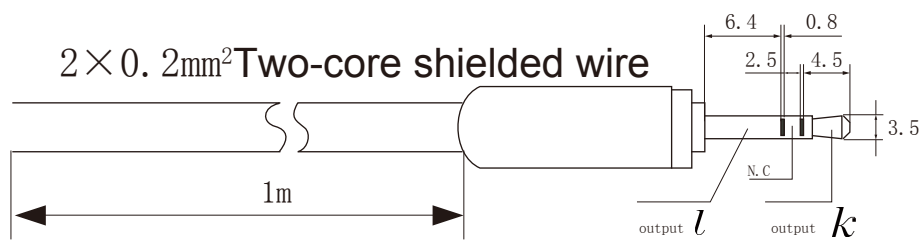
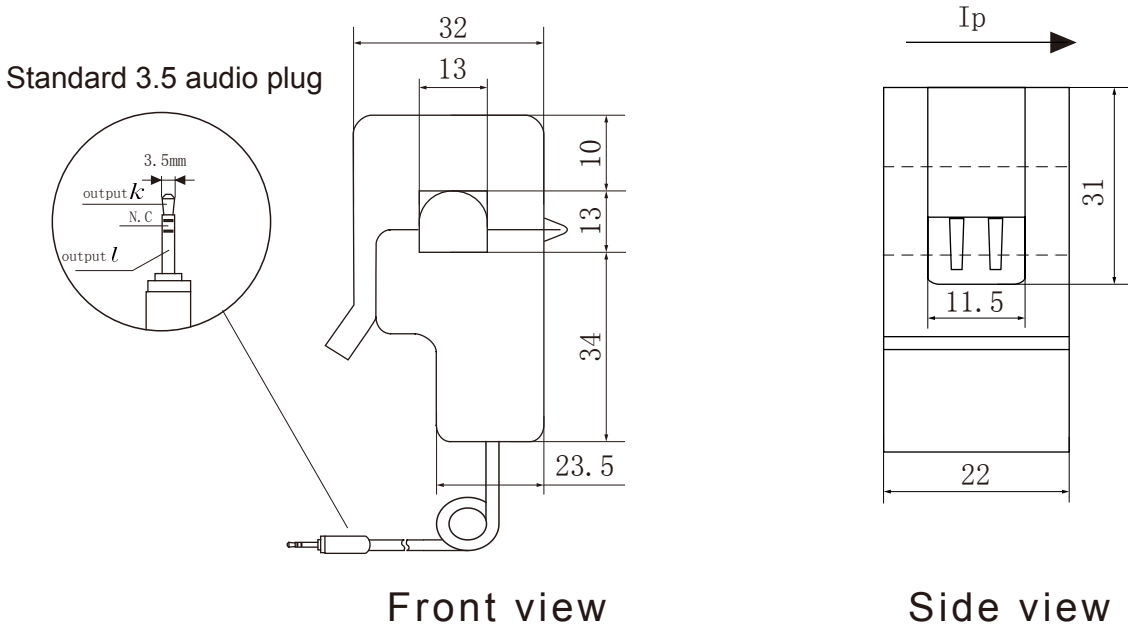

Standard three-pin plug diagram