

$\Phi 13\text{mm}$  Aperture Split core current transformer



Front view



Opening view

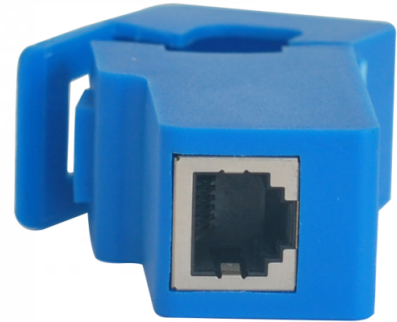

Bottom view

## Product features

- Safety lock buckle, simple installation
- RJ11 interface output
- Suspended type

## Product application

- Portable instrument
- Household metering
- Monitoring the load of machine

## Product advantage

- Small volume, Light weight
- Low cost
- High turns, High precision

## Installation diagram

Primary threading method:

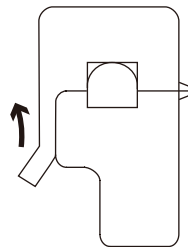

1. Open the buckle

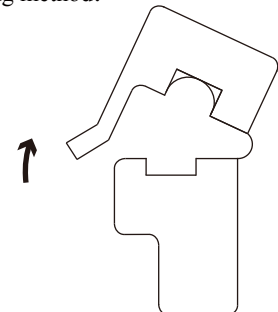

2. Open upward

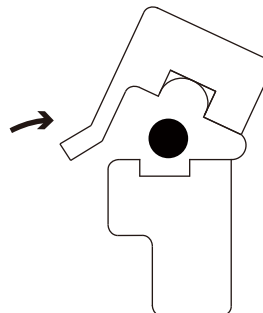

3. Put in lead wire

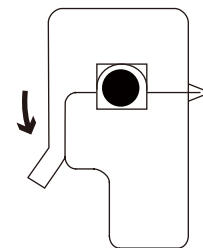

4. Fasten the buckle

**Typical technical index:**

- Material of core——Ferrite
- Working voltage——Phase voltage  $\leq 720V$
- Working temperature—— $-25^{\circ}C \sim +60^{\circ}C$
- Storage temperature—— $-30^{\circ}C \sim +90^{\circ}C$
- Frequency range—— $50Hz \sim 1KHz$
- Dielectric strength——Input (bare conductor) /output AC 800V/1min 5mA 50Hz  
Output/Outer shell AC 3.5KV/1min 5mA 50Hz

**Electrical parameters:** ( The following parameters are typical values and actual values will be subject to product testing )

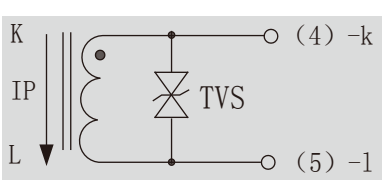
Model	Input current	Output current	Accuracy	Load resistance	Wiring schematic diagram:
SCT013-RJ11	50A	50mA	1%	10 $\Omega$	 <p>TVS: Transient voltage suppressor(7.5V) Current output type Secondary doesn't allow open circuit</p>
SCT013-RJ11	100A	50mA	1%	10 $\Omega$	
SCT013-RJ11	—	—	—	—	
SCT013-RJ11	—	—	—	—	

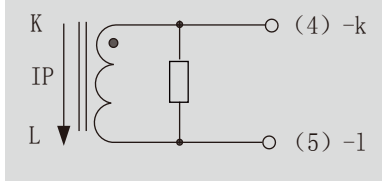
Model	Input current	Output Voltage AC	Accuracy	Load resistance	Wiring schematic diagram:
SCT013-RJ11	5A	0.333V	1%	$\geq 10K \Omega$	 <p>Built-in sampling resistance Voltage output type Secondary doesn't allow short circuit</p>
SCT013-RJ11	10A	0.333V	1%	$\geq 10K \Omega$	
SCT013-RJ11	15A	0.333V	1%	$\geq 10K \Omega$	
SCT013-RJ11	20A	0.333V	1%	$\geq 10K \Omega$	
SCT013-RJ11	25A	0.333V	1%	$\geq 10K \Omega$	
SCT013-RJ11	30A	0.333V	1%	$\geq 10K \Omega$	
SCT013-RJ11	50A	0.333V	1%	$\geq 10K \Omega$	
SCT013-RJ11	60A	0.333V	1%	$\geq 10K \Omega$	
SCT013-RJ11	100	0.333V	1%	$\geq 10K \Omega$	

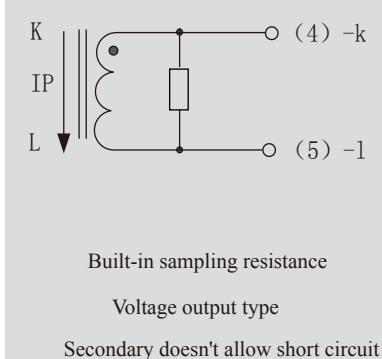
Model	Input current	Output Voltage AC	Accuracy	Load resistance	Wiring schematic diagram:
SCT013-RJ11	5A	1V	1%	$\geq 10K \Omega$	 <p>Built-in sampling resistance Voltage output type Secondary doesn't allow short circuit</p>
SCT013-RJ11	10A	1V	1%	$\geq 10K \Omega$	
SCT013-RJ11	15A	1V	1%	$\geq 10K \Omega$	
SCT013-RJ11	20A	1V	1%	$\geq 10K \Omega$	
SCT013-RJ11	25A	1V	1%	$\geq 10K \Omega$	
SCT013-RJ11	30A	1V	1%	$\geq 10K \Omega$	
SCT013-RJ11	50A	1V	1%	$\geq 10K \Omega$	
SCT013-RJ11	60A	1V	1%	$\geq 10K \Omega$	
SCT013-RJ11	100	1V	1%	$\geq 10K \Omega$	

Dimensions: (in:mm±0.5)

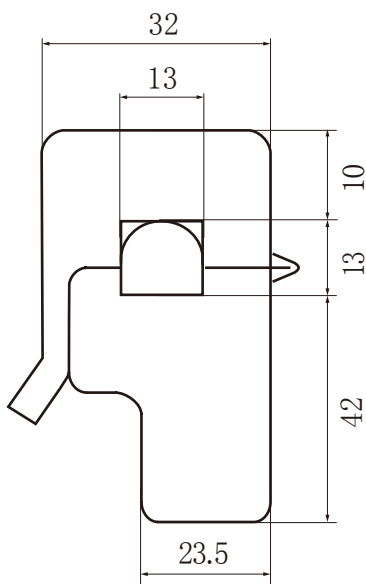

Front view

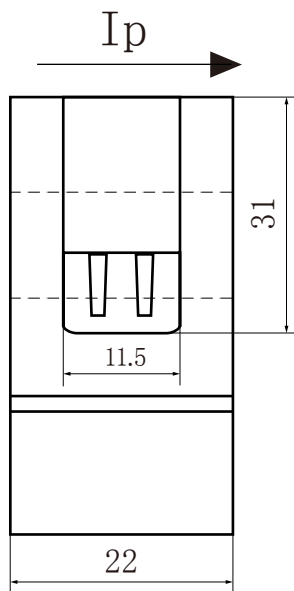

Side view

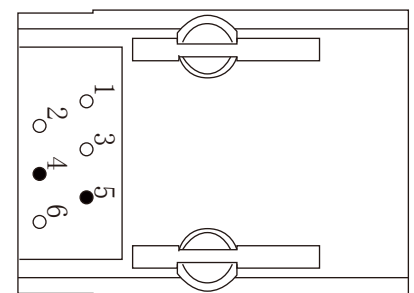

Interface terminal diagram