

Detect DC, AC and pulse current, high insulation between primary side and the vice side circuit.

Product picture printing is for reference only, subject to the actual product

Product application

- Metallurgy
- Welding machine
- Robot
- Inverter power
- Inverter speed controller
- UPS uninterruptible power supply

Product features

- Light weight
- Low power consumption
- Beautiful appearance
- Fast response time
- No insertion loss
- Sub-plate mounting and easy to use

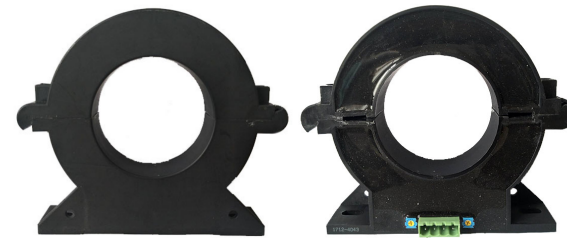

Electrical parameters: the following parameters are typical values, the actual values shall be subject to the actual measurement of the product

Rated input	±300A	±500A	±800A	±1000A	±1200A	±1500A
Input measurement range	±360A	±600A	±960A	±1200A	±1440A	±1800A
Rated output	±4V					
Accuracy	1%					
Linearity	1%					
Supply voltage	±12V/±15V					
Current consumption	≤16mA					
Load impedance	≥10KΩ					
Zero offset voltage	≤±15mV					
Response time	≤5μs					
Weight	542g					
Operation temperature	-10℃~+70℃					
Storage temperature	-25℃~+70℃					
Band width	DC~10KHz					
Dielectric strength	3KV 50Hz 1min					

Terminal definition:

- 1: V+
- 2: V-
- 3: Vout
- 4: 0V

Wiring diagram:

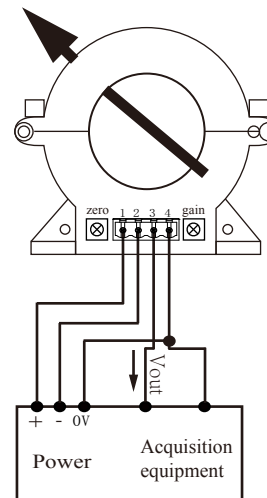

Connector:

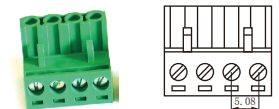

Crimping terminal fast plug
2EDG-5.08-4p spacing 5.08mm

Dimensions(in mm±0.5) :

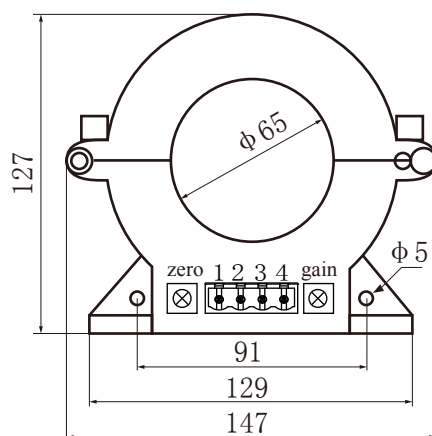

Front view

Current direction
Print surface ← Epoxy surface

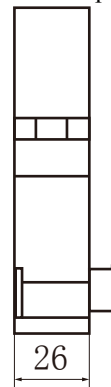

Side view

Fixed hole

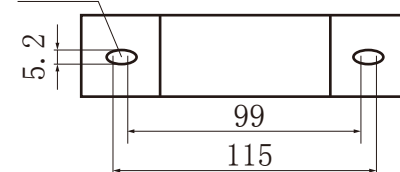

Bottom view