

Hall split core current transducer

suspension indtallation, terminal output.Detect AC current. High insulation between primary and secondary circuit

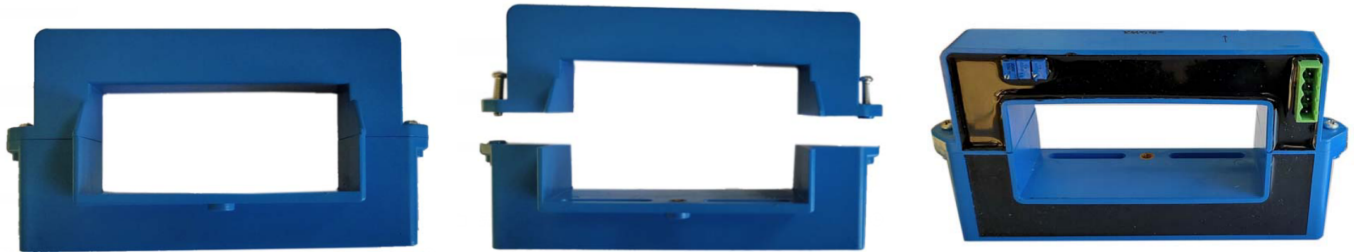

Installation diagram

Product features

- Light weight
- Low power consumption
- Good linearity
- No insertion loss
- Fast response time
- Good anti-interference ability

Product application

- Railway
- Metallurgical
- Welding machine
- Robot
- Motor
- Inverter power supply
- Variable frequency governor
- Uninterrupted power supply and communication power supply

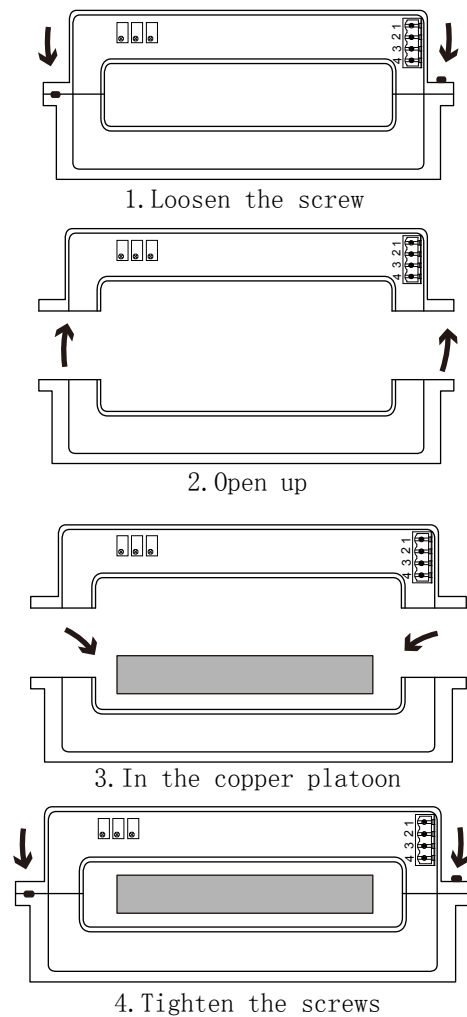

Electrical parameters: (The following parameters are typical values and actual values will be subject to product testing)

Remarks

Rated input	600A	700A	800A	1000A	1200A	1500A	2000A	Standard input
Input measurement range	720A	840A	960A	1200A	1440A	1800A	2400A	Default is 1.2 times the input rating
Rated output	0-20mA/4-20mA/0-5V/1-5V/0-10V							Output one of five 0-10V output +24V power supply
Accuracy	1%							
Linearity	0.5%							
Supply voltage ($\pm 5\%$)	+12V / +24V							Supply voltage range $\pm 5\%$
Current consumption	$\leq 48\text{mA} + I_o$							Reference will be subject to the measured
Load impedance	Current type output: 250 Ω (Typification)			Voltage type output: $\geq 10\text{K}\Omega$				
Zero offset voltage	Current type output: $\pm 0.08\text{mA}$			Voltage type output: $\pm 15\text{mV}$				TA=25°C
Response time	$\leq 350\text{mS}$							Reference will be subject to the measured
weight	761g							Reference will be subject to the measured
Operating temperature	-10~+70°C							
Storage temperature	-25~+70°C							
Band width	DC~400Hz							
Delectric strength	6KV 50Hz 1min							

Instruction for use:

1. Connect the wires correctly according to the marked connection mode
2. With hole measurement, response time and following the speed for the best
3. Faulty wiring can lead to product damage and output uncertainty

Safe operation:

- *Please read this specification carefully before use.
- *When you need to move the product, please be sure to disconnect the power and all the connected cables.
- *If found shell, devices attached to the fixed parts, wire, or have any damaged, please immediately deal with hidden dangers.
- *If there is any doubt about the safe operation of the equipment, the equipment and the corresponding accessories should be closed immediately, and the fastest time for troubleshooting.

Proclamations:

As our products are constantly being improved and updated, we reserve the right to modify the content of this specification at any time without prior notice.

Dimensions(in mm±0.5) :

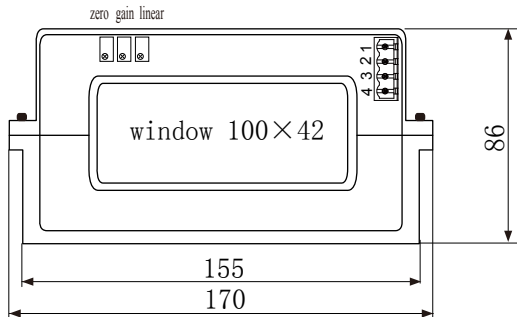

Not to distinguish the direction

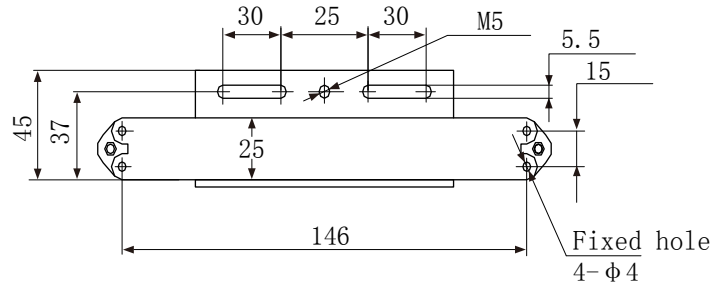

Connector Illustration

Wiring diagram:

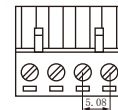
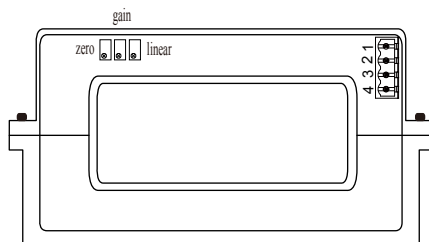

Crimping terminal fast plug 2EDG-5.08-4p spacing 5.08mm

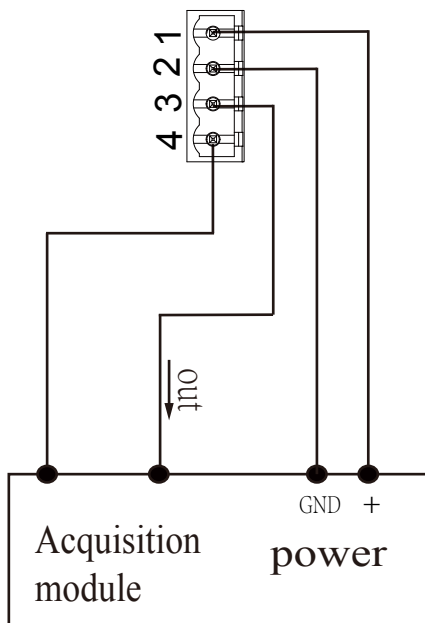

Terminal definition:

- 1: +V
- 2: GND
- 3: out
- 4: GND

- ※①The auxiliary power supply with ripple small ($\leq 20\text{mV}$) is selected
- ②Switch on auxiliary power
- ③Auxiliary power is connected to the transmitter
- ④Transmitter detects the primary current
- ⑤Both GND internals are not isolated