

Characteristics:

1. Vacuum epoxy encapsulated, 100 °C/6 h high temperature aging, twenty years of life, high dielectrical strength.
2. High quality H18 silicon steel sheet, low temperature, high efficiency.
3. PBT engineering plastic, environmental protection, flame retardant, 120 degrees without deformation.
4. Reasonable structure, easy installation, low noise, strong earthquake, sealed waterproof, moistureproof.

Technical index:

Mounting type: Sub-plate mount

Flame resistance : UL94-V0

Insulation class: B

Waterproof class: IP67

Wire length :90cm±5cm

Operation temperature: -30 °C ~ +40 °C

Work frequency: 50Hz~60Hz

Dielectric strength: Pri/Sec 3.5KV 50Hz 1min 5mA

Sec/Sec 500V 50Hz 1min 5mA

Electrical parameters: The following parameters are typical values. The actual values shall be subject to the actual measurement of the product

Primary voltage	110V	220V	230V	380V	Unit
Primary voltage range	± 10				%
Power	15				VA
Voltage regulation	≤ 17				%
Temperature rise	≤ 20				°C
No-load loss	≤ 0.9				W
Weight	500				g

Dimensions (in mm±0.5)

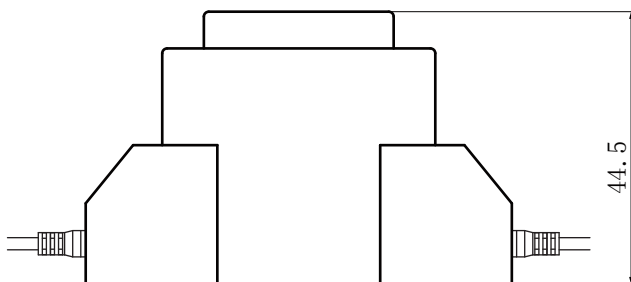

Front view

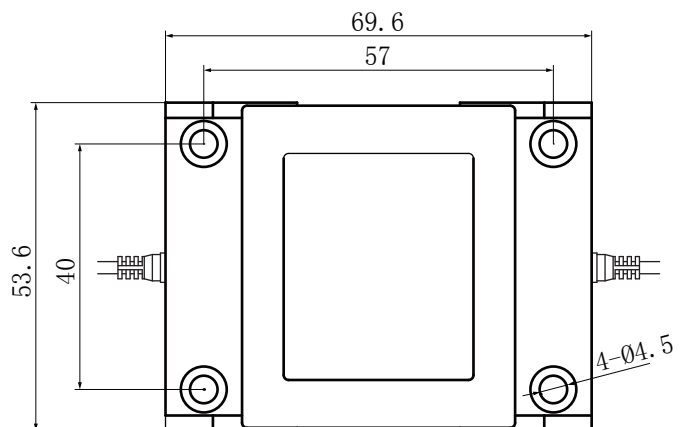

Top view

Product picture print for reference only, subject to the actual product



Standard output parameters table:

(Delivery is subject to full load voltage)

Secondary output voltage		Secondary no-load voltage		Secondary full-load current	
Single	Double	Single	Double	Single	Double
6V	-	6.7V	-	2500mA	-
7.5V	-	8.4V	-	2000mA	-
9V	-	10.1V	-	1666mA	-
12V	-	13.4V	-	1250mA	-
15V	-	16.8V	-	1000mA	-
18V	-	20.1V	-	833mA	-
24V	-	26.9V	-	625mA	-

Schematic diagram:

